

Work with

- * ATI
- * Barber coleman
- * Honeywell
- * Johnson
- * Landis & Gyr
- * Satchwell
- * Sauter
- * Staefa
- * T/A
- * TEG
- * Others

Electric Rotary Actuators

DC motor drives, Modulating
with electronic safety system

AUR65.1.

AUR65.1212 0

- Aux. output 1=spst 2=140Ω 3=1000Ω 9=Converter
- Output Torque(Nm); 1=7.5N 2=15 3=20 4=30 9=Options
- Running time; 1=120s 2=60s 3=30s 4=15s 5=10s 6=5s 9=Options
- Supply voltage
1=110Vac, 2=24Vac, 3=220Vac, 4=380Vac, 7=12Vdc, 8=24Vdc
- 1=Rotary 2=Linear 9=Options
- Version No.
- Input signal: 2=On/Off, 3=3-pos. 220Vac, 5=4...20mA 6=0...10Vdc
7=0...20Vdc, 8=3-pos. 24Vac, 9=0...135Ω
- R=Damper
- Type of drive motor
I= Induction, Q= Synchronous, S= Servo, U= DC, Z= Stepper
- Product group: A= Actuator

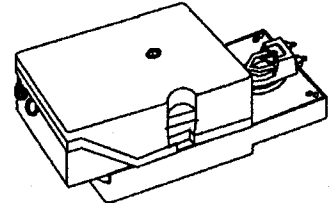

Description

Electrical actuator, 0...10Vdc control, rotating angle is 90°, DC motor drive without spring return.

Application

In heating, ventilating, air conditioning and other industrial installations for control of air dampers, fire dampers and other ventilating openings located not in the living spaces.

The application allows a bit of noise from the units. Signals from other controllers are also acceptable.

Ordering Specification

When ordering, please give full designation and type reference of unit:

Ex: AUR65.12120 Electrical Damper Actuator Proportional, 0...10Vdc Rotary type, 120s, 24Vac, 15Nm for aux. unit

Technical Data

Supply voltage	24V ac/dc ± 20%
Frequency	50Hz / 60Hz
Power source	DC motor
Power consumption	3VA...
Running time	125- 200s at 50/60Hz
Model of control	Proportional(std)
Travel / angular rotation	90°(std)
Noise level	>45[dB]
Nominal Force[f]	12-18Nm(std)
Control signal(Y)	
Voltage	0...10Vdc
Current	0.1mA max.
Control signal(R)	
Resistance	0...1000Ω (0...100%)
Control output(U)	
Voltage	Optional
Current	0...10Vdc(std) 0.5mA max.
Weight	1.Kg
Permissible amb.temp.	
Operation	-15...+50°C
Transport & storage	-30...+65°C
Permissible amb.humid.	class D to DIN 40040
Protection standard of housing	IP54 to DIN 40050
Max. medium temp.	+150 °C
Cable entry glands	PG11

Accessories;

- position indication unit
- potentiometer -0...140
- potentiometer -0...1000

position alarm switch

- snap action switch 10(3)A 24...250Vac
- Estimated life time
- Drive motor App. : 400,000 cls
- Gear train App. : 1,000,000 cls

Summary of types

Type Nr.	Output Torque	Running time 50/ 60Hz	Space for Aux.units			
			0	1	2	3
AUR65.12110	7.5Nm	125s - 200s	0	SW	140Ω	1000Ω
AUR65.12120	15Nm	125s - 200s	0	SW	140Ω	1000Ω
AUR65.12130	20Nm	125s - 200s	0	SW	140Ω	1000Ω
AUR65.12140	30Nm	125s - 200s	0	SW	140Ω	1000Ω
AUR65.12210	7.5Nm	40s - 90s	0	SW	140Ω	1000Ω
AUR65.12220	15Nm	40s - 90s	0	SW	140Ω	1000Ω
AUR65.12230	20Nm	40s - 90s	0	SW	140Ω	1000Ω
AUR65.12310	7.5Nm	20s - 50s	0	SW	140Ω	1000Ω
AUR65.12320	15Nm	20s - 50s	0	SW	140Ω	1000Ω
AUR65.12410	7.5Nm	10s - 30s	0	SW	140Ω	1000Ω

Function

The actuator is controlled by a standard signal of 0...10Vdc received from conventional electronic controller or DDC unit. It provides electronic position control which, in conjunction with ATI or any compatible venturi type air dampers or air valves, gives an equal percentage valve characteristic.

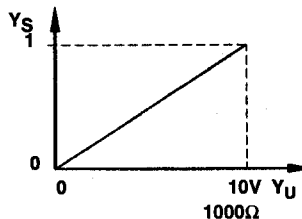

Correlation between control signal and correcting variable

Y_S = Correcting variable
Y_U = control signal 0...10Vdc
Y_R = correcting signal 0...10Vdc

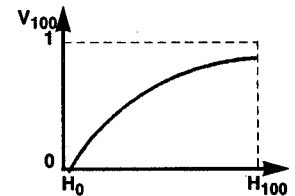

Correlation between valve stroke and volumetric flow

V₁₀₀ = volumetric flow
H_{..} = valve stroke

Auxiliary units

- Control output U with a 0...10Vdc control signal allows control of the following units:
- Indication units
- On / Off switching units

Design Features

Actuator are supplied as separate units. Assembling them requires neither special tools nor adjustments.

- Maintenance free electrical actuator with DC motor
- A switch on PCB can reverse the rotation of the actuator.
- Blocking proof gear train with self-lubrication sintered bearings
- Quick mounting bracket make easy installation.
- Gear train is made of aluminum die-cast and specially coated for corrosion proof.
- Important gears are made of sintered metal or special tool steel and heat treatment.

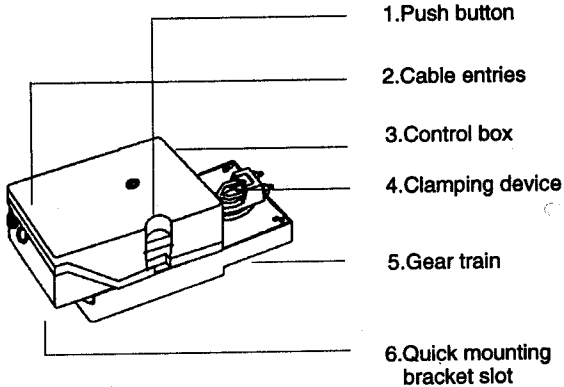

Application Advice

For further information on the complete regulating unit consist of actuator and valve also refer to the Data Sheet of the various type of valves, 43000... 44999.

Observe the permissible temperatures. For details refer to <Application > and <Technical Data>

Data Sheet 34001 contains basic system data on POLYTEK. All hints and explanations given in this sheet must be observed.

All units connected to terminals Y and U, together with the AUR..., must be connected to the same G0.

The factory fitted link across terminals R and M may be removed only if a unit is connected between these terminals.

Mounting and Installation Advice

Mounting positions:

The actuator's mounting instructions are supplied in the box of the unit.

Commissioning Advice

When commissioning the installation, check the wiring and make a functional test.

Wiring Diagram

Internal Diagram

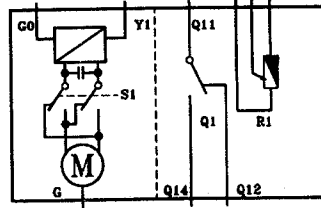

G, G0 = Operating voltage 24Vac
G = system potential (SP)
G0 = system neutral (SN)
Y = control signal 0...10Vdc
S1 = Change-over switch
Q1 = Switch unit
R1 = Potentiometer
M = Motor

Connecting terminals

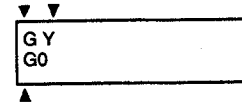

Wiring diagram

The wiring diagram shows all possible connections. How many and which of these are used depends on the system involved.

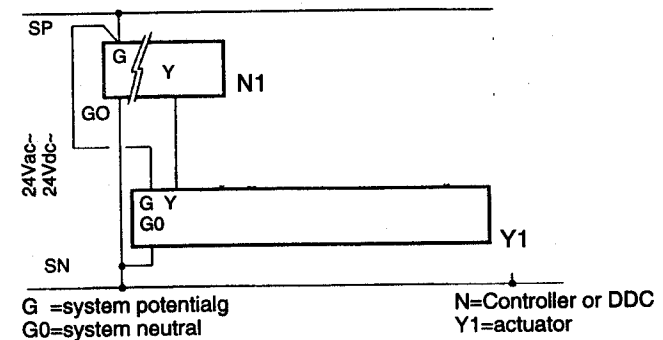

Dimensions

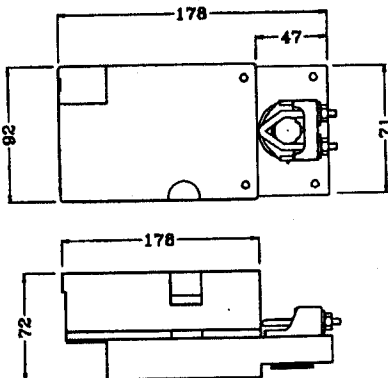

Dimensions in mm