

# eliwell

ISO 9001



Eliwell Controls Srl

Via dell' Industria, 15 Z. I. Paludi  
32010 Pieve d' Alpago (BL) - Italy

Telephone +39 0437 986 111

Facsimile +39 0437 989 066

Sales:

+39 0437 986 100 (Italy)

+39 0437 986 200 (other countries)

[saleseliwell@invensyscontrols.com](mailto:saleseliwell@invensyscontrols.com)

Technical helpline: +39 0437 986 300

[techsuppeliwell@invensyscontrols.com](mailto:techsuppeliwell@invensyscontrols.com)

[www.eliwell.it](http://www.eliwell.it)

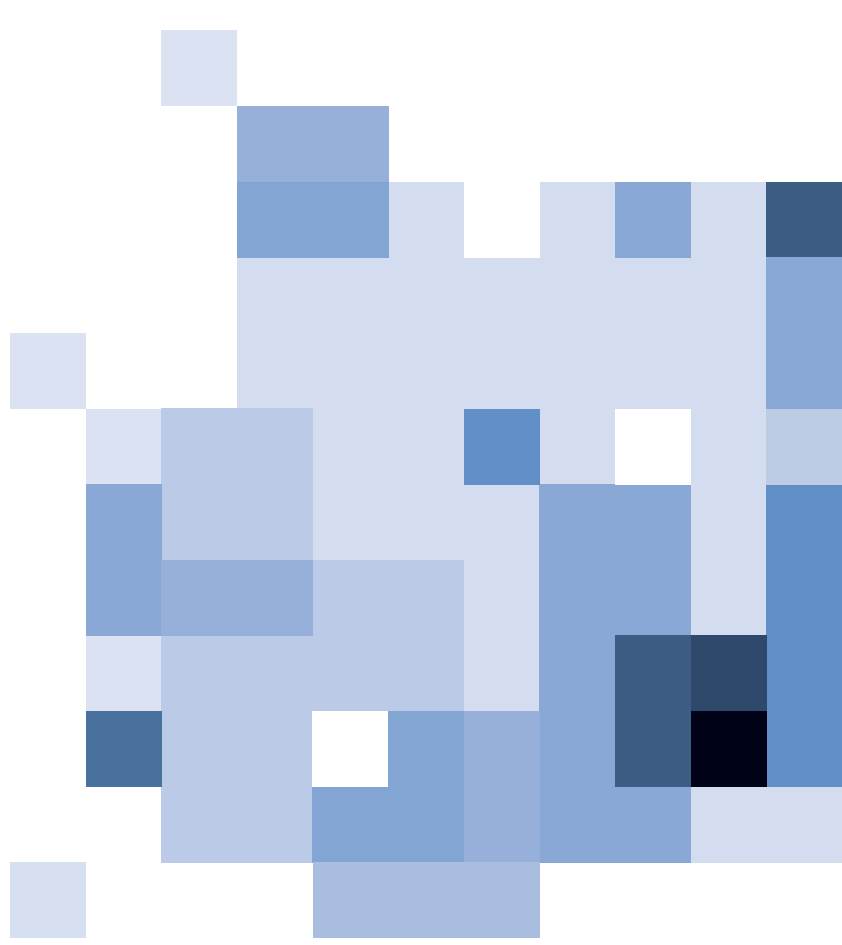

# EWCM Controllers for compressor unit

## Technical Data



## EWCM Controllers for compressor unit

The new **EWCM** series of Eliwell controllers to manage compressor units guarantees higher efficiency in the machine room and an advanced management of energy savings

### 13 DIN Rail 18 DIN Rail

The new range of 13-18 DIN Rail EWCM controllers was designed for the most complex and evolved system solutions, providing solutions for BT and TN direct expansion units and for dual temperature unified units with single condensation. It is however suitable also for controlling systems with indirect expansion and secondary fluids. The controllers of the new range are available with 13 and 18 DIN Rails and a keypad with graphic LCD display.



### EWCM 32x74

With the EWCM 32x74 series Eliwell offers a series of compact and inexpensive parametric controls. Extremely easy to use and install, they are ideal for the complete control of small single-circuit direct expansion refrigeration units, with or without control of the condensing unit. Their use can however be extended to applications which require control by steps, hot/cold in temperature or direct/inverse in pressure.



### Typical applications

#### Commercial refrigeration

- Retail trade (Hypermarket, Supermarkets, Convenience Stores, Food shops)
- Catering (Hotel, Restaurants)

#### Industrial refrigeration

- Food processing
- Food distribution
- Other industries (chemical, pharmaceutical, skating facilities).

### Characteristics

#### Economic savings

- In the purchase of the system
- Reduction of installation times for rapid system start-up
- Savings on operating costs due to reduced electrical consumption
- Minimum maintenance over time

#### Compliance with environmental standards

- Reduction of the amount of refrigerants in new systems
- Adequate refrigerants in terms of performance
- Non-polluting ecological refrigerants (CO2) which make it possible to use smaller compressors with lower consumption

#### Connectivity

- Accessibility via Web and Modbus RTU compatibility for integration in the supervision systems of third parties.
- Integration with the Televis supervision network
- Rapid configuration via Eliwell Copy Card USB

#### Simplicity

- Easy start-up of new systems
- Simplicity in the restructuring of existing systems

#### Reliability

- Safe cooling guaranteed
- Maximum functionality of products used

## 13DIN Rail EWCM (8400-8600-8900-9100) - 18DIN Rail EWCM (9900)

### DIN Rail solution for the control module and remote keypad for panel installation.

Available in two formats, with 13 and 18 DIN Rails, to be installed inside electric panels on DIN rail; this format is one of the most common installation systems on the market. The keypad for panel installation is available in DIN standard format with the same dimensions as the installation hole of the EWCM 800/900, thus making its replacement easier.

Complete IO arrangement:

- up to 19 relays
- up to 3 analog outputs
- up to 20 digital inputs
- up to 7 analog inputs

A 100...240V universal power supplier makes it possible for all the models of the new range to be power supplied directly from the mains without any need for a transformer. This feature further increases versatility and ease of installation.



### EWCM models

13DIN	EWCM8400: 4 compressors and/or inverter compressor
	EWCM8600: 6 compressors and/or inverter compressor
	EWCM8900: 9 compressors and/or inverter compressor
	EWCM9100: 11 compressors and/or inverter compressor
	8 fans and/or inverter fan
18DIN	EWCM9900: 12 compressors and/or inverter compressor
	8 fans and/or inverter fan
	2 circuits managed

## USER INTERFACE

### New graphic LCD keyboard

The new keypad with backlit graphic LCD interface is power supplied directly by the control module. The main panel displays in one single screen the status of compressors and fans indicating in separate sections the values read by the intake and delivery probes. Furthermore, its dynamic layout automatically fits the type of system managed.

### Rapid access menu

For an immediate control of the system:

- display and modification of the adjustment setpoint
- rapid display of active alarms
- display of the value read by the probes
- display of the compressor and fan status menu with graphic indication of the active power on each load
- modification of the display unit of measurement for both intake and delivery sections (Bar, PSI, °C or °F)
- display, in a reduced parameter menu, of the EWCM 800/900 parameters only, for an easy retrofit of the controller

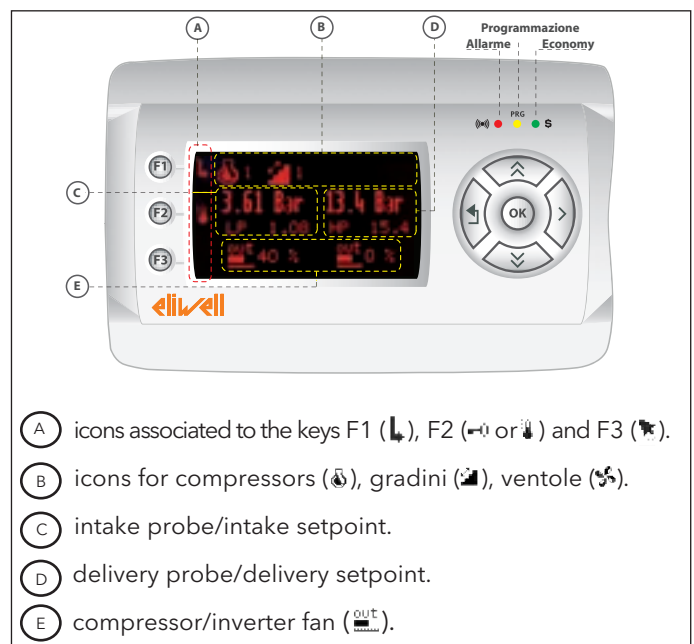

## SYSTEM CONFIGURATION

Thanks to the wide IO range available and the complete configurability, the new EWCM can satisfy the most complex system configurations:

- Management of systems up to 2 single-unit refrigeration circuits with single-step or multiple-step compressors;
- Compressors of various power;
- Inverter compressor;
- Simultaneous operation of step compressors and inverter compressor with the possibility of configuring a backup relay for the compressor piloted by inverter when an inverter fault is signalled.

Condensation control can be configured via:

- Step fans
- Fan piloted by inverter

- Simultaneous operation of step fans and inverter fan with the possibility of configuring a backup relay for the fan piloted by inverter when an inverter fault is signalled.

### Quick Start

Menu dedicated to the initial configuration of the machine or system for a quick and efficient assignment of the system resources.

This function allows the optimal allocation of the minimum number of resources indispensable for the application to operate, also based on the set parameters.

In any case it is possible to intervene manually to modify the default configuration or the result of the automatic I/O assignment.

## COMBINED DIGITAL + INVERTER SYSTEMS

### Combined digital + inverter systems for compressors and fans

The number of power steps is determined on the basis of the difference between the value detected by the control probe and the set point, whereas the inverter power is modulated continuously between the activation/deactivation of two successive power steps. Activation of a power step occurs when the inverter reaches the maximum power setting before repositioning itself at the minimum control value. After activating the last power step, the inverter continues to modulate between 0% and 100% in the section highlighted in the diagram before remaining ON outside the proportional band.

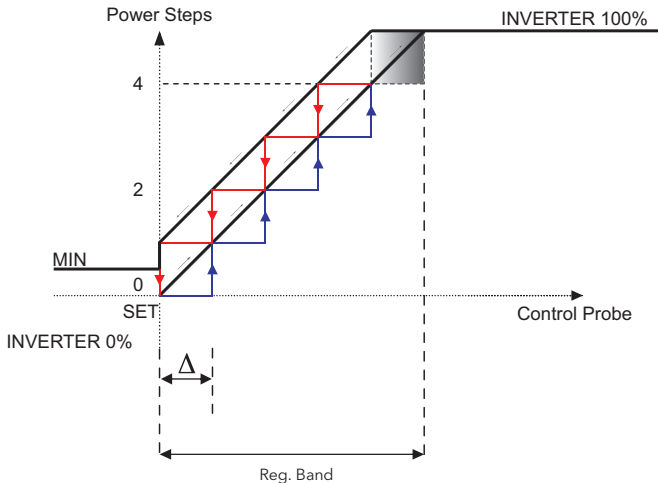

## BACKUP ON INVERTER FAULT

In systems which use a modulating control with inverter it is possible to configure a backup relay which, in the presence of the inverter fault signal, enables the load controlled by the inverter to remain active.

The backup system is intended for the following applications:

- Combined digital + inverter systems for compressors and fans
- Modulating condensation control with inverter only.

In the case of modulating control of multiple fans in parallel, a backup relay may be configured for each fan.

No inverter error present:

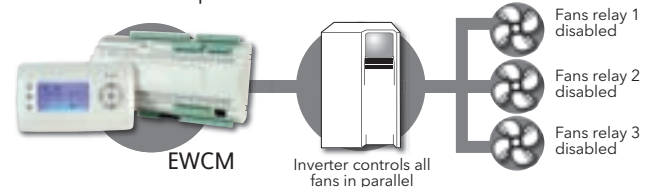

Inverter error present:

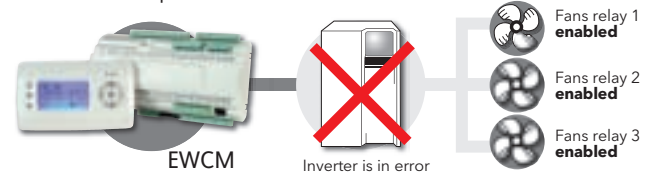

## EFFICIENCY AND ENERGY SAVINGS

The Energy Saving function perfectly controls the intake and delivery adjustment set points on the basis of ambient conditions. The set point control can be fixed or dynamic with the possibility of selection from the parameter and can be run from:

- Dedicated digital input
- Timeband programming
- Keypad
- Serial via Televis/ModBus RTU

### Wide range of refrigerants

- R22
- R134A
- R502
- R404A
- R407C
- R507
- R717 (Ammonia - NH<sub>3</sub>)
- R410A
- R417A
- R744 (Carbon Dioxide - CO<sub>2</sub>)
- R402A
- R402B

The conversion of the fundamental values of the unit of measurement selected is automatic.

### Intake set point management

- Fixed: a fixed quantity is added to the intake set point
- Dynamic: the quantity added is dynamic and depends on the indoor ambient temperature (typically the display area of the supermarket)

### Delivery set point management

- Fixed: a fixed quantity is subtracted from the delivery set point
- Dynamic: the temperature(/pressure) of condensation fluctuates with the outdoor temperature, leading to savings that increase as the outdoor temperature decreases. The presence of a temperature probe that monitors the refrigerant liquid also makes it possible to control the undercooling.

The use of frequency variation devices (inverters) controlled by PID controllers, in addition to optimizing the use of the resources, significantly contributes to obtaining an optimal floating condensation pressure.

## TIMEBAND MANAGEMENT

An RTC with annual calendar and a long life lithium battery allows the activation of functions or controllers to be programmed at set times.

Programming is on a daily basis, subdividing each day of the week into 6 periods, which can be enabled singularly, within which the following functions can be activated:

- Reduced intake and delivery set point

- Auxiliary relay activation
- Energy Saving
- Heat recovery

The week can also be subdivided into two periods (working days and holidays) with dedicated settings.

## DIAGNOSTICS

The diagnostic function of the new EWCM is comprehensive, with the possibility to also configure the intervention mode for each alarm. The alarm history saves the last 50 alarms with indication of the error code and the date/time of activation.

### Managing the operation history

The operation history saves the mean, maximum and minimum data recorded by the controller for the main values of the system:

- intake and delivery temperature/pressure
- compressor and fan power
- number of activations of the pressure switches and machine block alarms

The daily data and the weekly mean values are available up until the last quarter. The data may be downloaded on the Eliwell Copy Card USB in order to be displayed directly on a PC.

### Maximum delivery alarm prevention

The maximum delivery alarm prevention is a control algorithm dedicated to limit or reduce the system power as the value read by the delivery probe gets closer to the alarm threshold. Two separate thresholds define when the power must be limited or progressively reduced upon the further increase of the delivery value.

The maximum duration of the prevention algorithm can also be defined: if the power reduction remains active for too long without benefits, the prevention algorithm is disabled for a time that can be set.

## CONNECTIVITY

### Connection to the Televis System remote management system or Modbus RTU

All the EWCM models are provided with RS-485 serial for the integration of the Eliwell Televis supervision System without additional modules.

Each of the EWCM model also supports the standard ModBus RTU protocol in native mode. This allows integration in third party supervision systems, and greater accessibility to all the system variables and to all the parameters.

### Rapid configuration with Eliwell Copy Card USB

The controllers of the EWCM family may be interfaced with a PC via the Eliwell Copy Card USB, without using external accessories for immediate device configuration and maintenance. The Eliwell Copy Card USB is equipped with a USB connection compatible with the USB ports of the PC and an EWCM connection, thus providing:

- fast programming and copying of parameters
- glossary updating and copying among the various controllers
- alarm and operation history saving
- adjustment algorithm updating

The recognition of the device model connected prevents any incorrect programming and guarantees complete reliability.

### Display of the resources of the controller using the browser

Accessibility via WEB on all the EWCM models is guaranteed by the Televis system or the WebAdapter. Connecting to the Web via Ethernet and a WebAdapter module (external or integrated in the 13/18 DIN instrument) has never been easier and safer (using http and https protocols). Connecting EWCM devices to your company or global network offers an unbelievable advantage for those who have to monitor controllers located across the world daily, also via a handheld terminal.

Using just an internet browser, with no additional software required, it will be possible to:

- Display and modify a controller's parameters;
- Display a controller's status;
- Display a controller's alarms;
- Modify the time and date of a controller

Furthermore, the security management, with 2 password levels, lets you protect the device and control undesired access thus also guaranteeing remote control via VPN and ADSL.



**ELECTRIC DIAGRAMS 13 DIN Rail EWCM FAMILY**

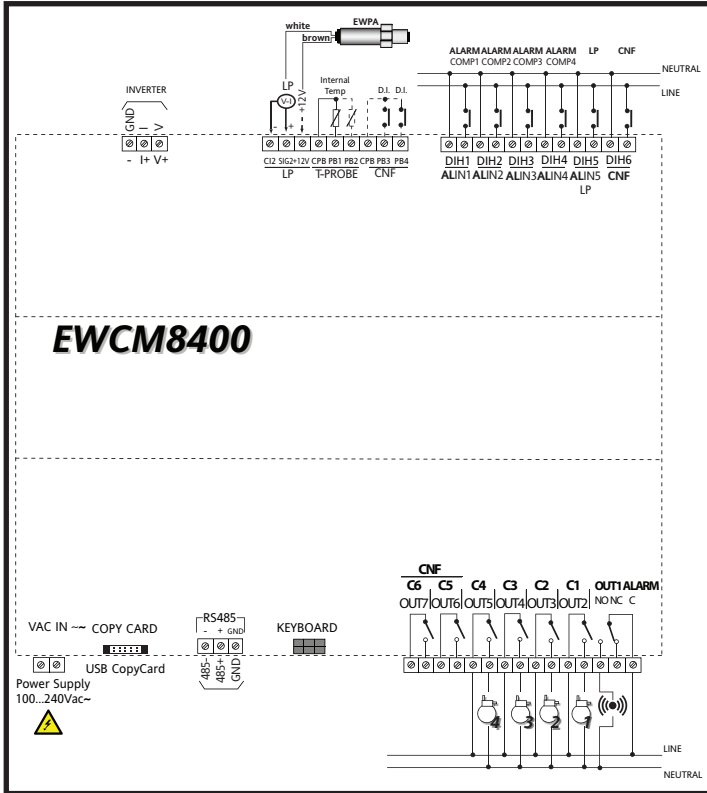

**EWCM8400**

4 compressors and/or inverter compressor

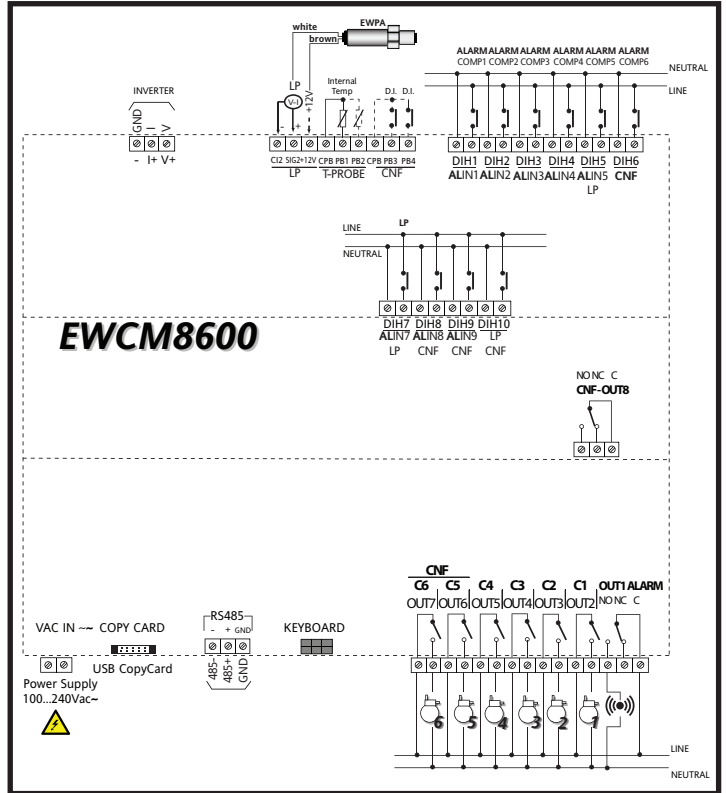

**EWCM8600**

6 compressors and/or inverter compressor

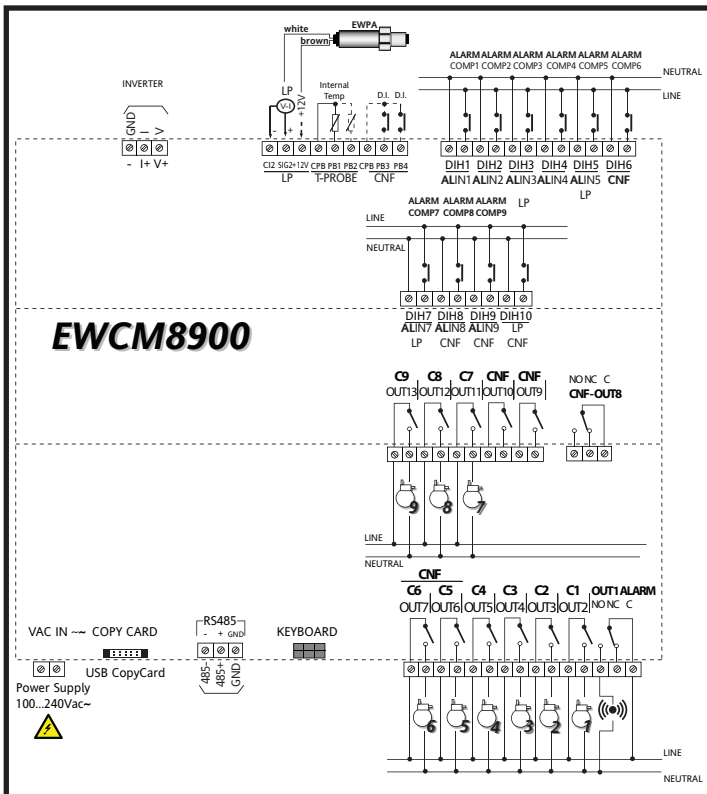

**EWCM8900**

9 compressors and/or inverter compressor

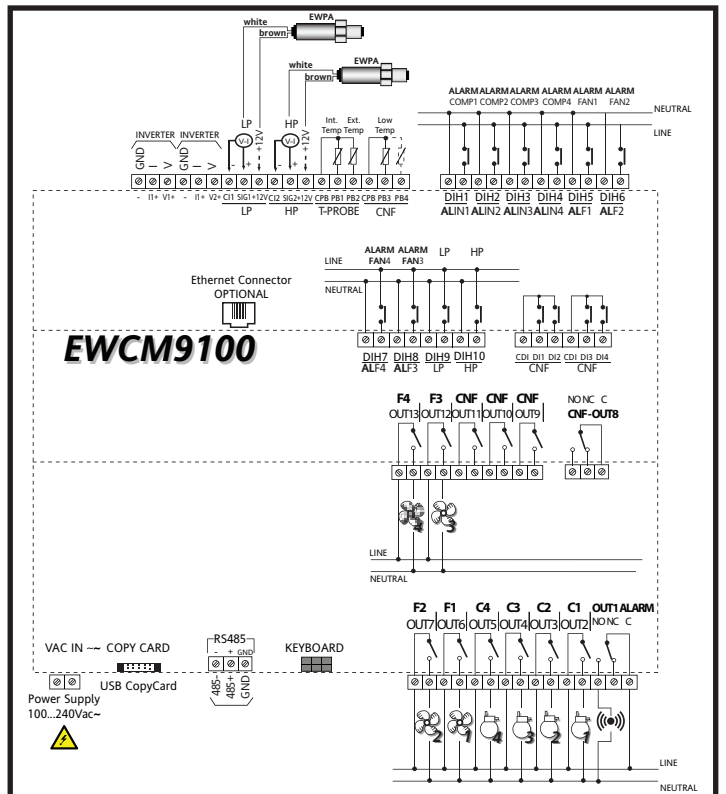

**EWCM9100**

11 compressors and/or inverter compressor  
8 fans or inverter fan

## EWCM 18 DIN Rail ELECTRIC DIAGRAM

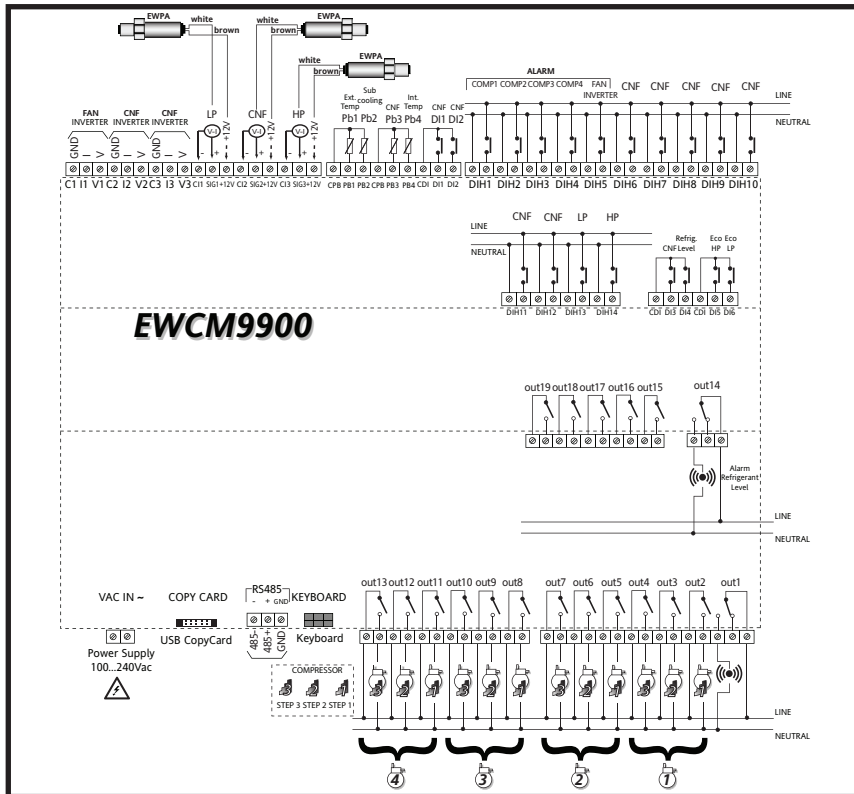

12 compressors and/or inverter compressor  
8 fans or inverter fan  
2 circuits managed

## REPLACED EWCM CODES

Model	Code replaced	Description
8400	EM8A151700	EWCM 840/S 230V
	EM8A251600	EWCM 840/S NTC - 110V
	EM8A251700	EWCM 840/S NTC - 230V
8600	EM8B151700	EWCM 860/S - 230V
	EM8B251700	EWCM 860/S NTC - 230V
8900	EM8C151750	EWCM 890/S - 230V
	EM8C251700	EWCM 890/S NTC - 230V
	EM9D151650	EWCM 890/S - 110V
	EM7C151700	EWCM 809/NH3/S
9100	EM7C351700	EWCM 809/NH3/P/S
	EM9D151750	EWCM 900/S - 230V
	EM9D151753	EWCM 900/S - 230V SPECIAL
	EM9D251700	EWCM 900/S NTC - 230V

## PART NUMBER 13-18 DIN

	Code	Description
<b>8400</b>	EM34AG1x1BHyy	EWCM 8400 13D
<b>8600</b>	EM34DH1x1BHyy	EWCM 8600 13D
<b>8900</b>	EM34BH1x1BHyy	EWCM 8900 13D
<b>9900</b>	EM83CI3x0BHyy	EWCM 9900 18D
<b>9100</b>	EM35BH2x1zHyy	EWCM 9100 13D

yy	z	x	Description
0A			Version WITH manual
99			Version WITHOUT manual
B			External WEB module (optional)
D			Integrated WEB module
A			IT (Italian) / GB (English)
B			GB (English) / IT (Italian)
C			FR (French) / GB (English)
D			ES (Spanish) / GB (English)
E			SV (Swedish) / GB (English)
F			DE (German) / GB (English)

LEGENDA



## EWCM 4120 - 4150 - 4180

With the EWCM 4120, 4150 e 4180 series Eliwell offers a new series of compact and inexpensive parametric controllers. Extremely easy to use and install for the complete control of small refrigeration units, they are available for 32x74 panel installation.

All the inputs and outputs are independent and configurable, thus ensuring adaptation to most applications that require a control by steps or a modulating control of compressors and fans:

		4120	4150	4180
Digital outputs	Relay	4	5	5
	Open Collector	1	1	1
Analog outputs	TRIAC	1	/	/
	PWM - Open Collector	1	2	2
	0...10V, 4-20 mA, 0-20 mA	/	1	1
Digital inputs	Clean contact	7	7	7
Analog inputs	4-20 mA, ratiometric 0-5V, 0-10V, NTC, DI	2	2	2

All models include an internal clock (RTC) with an annual calendar and a TTL connector for a Copy Card or a Personal Computer (using the suitable interface) for connection to the Televis System/ModBus RTU.

The already broad IO arrangement can be further extended by connecting an external relay to the low voltage digital output or expansion modules for fan control at the powered and PWM analog outputs.



EWCM 4120-4180



EWCM 4150

### EWCM models

- 4120: 4 whole compressors and TRIAC output for fan control
- 4150: 4 single-stage compressors and alarm relay
- 4180: 4 whole compressors and alarm relays, powered output for fan control using an external module

## USER INTERFACE

The family uses a highly efficient display to view the values monitored and the status of the system; in particular:

- monitor the user status
- monitor the presence of alarms
- display the set unit of measurement
- display the activation percentage of the modulating loads.

The controller for navigation is equipped with 4 keys to quickly access the main menu to modify Set Points, the Adjustment Band, to customise the current display and to browse in the menu organized in folders.

In addition there are 2 levels of safety for the parameters (Manufacturer and Fitter).

Symbols / KEYS	Description	Front icon
	Configurable user LED. Factory setting compressor on	
	Configurable user LED	
	Programming menu	
	Pressure values displayed in Psi	
	Pressure values displayed in Bars	
	Temperature values displayed in °C/°F	
	Heating. HEATING mode	
	Cooling. COOLING mode	
	Configurable user LED Factory setting fan power bar	
	Alarm. If fixed alarm ACTIVE, if flashing alarm SILENCED	



## COMPLETE MANAGEMENT OF THE UNIT

### Complete management of the unit with control by steps or modulating control of compressors and fans

The controller allows:

- The control of the intake temperature or pressure of a single circuit with a modulating compressor or up to 4 whole or partial compressors (or combinations of compressors) for a maximum of 4 steps in total (proportional or Neutral Zone). The number of partializations can be individually configured for each compressor (for example it will be possible to manage a circuit with a whole compressor and one with 3 power steps).
- Control of the condensation temperature/pressure with inverter fan or up to 4 digital fans (proportional or Neutral Zone) with protection input by single load or common to the entire fan battery.

Modulating control of compressors and fans through an analog voltage or current output, with the possibility of configuring a start/stop relay for inverter.

Even more precise adjustment of the intake pressure in hundredths of Bars (0.01 Bar):

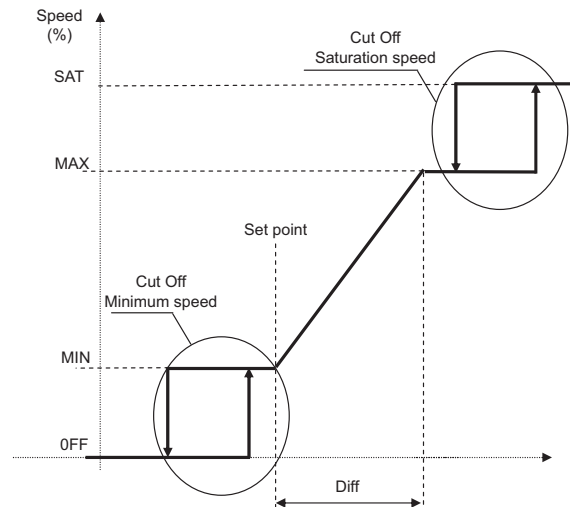

## COMPRESSOR AND FAN START-UP POLICIES

The possibility of managing start-up policies for compressors and fans that are based on the actual operating hours allows an efficient use of the system and increased durability of its components with a consequent reduction of maintenance.

### Compressors

- **Fixed sequence:** the power is distributed starting from the compressors with a lower index in a way to have, at any particular time, maximized supply levels of the compressors with a lower index.
- **Saturation:** the power is distributed on the lowest number of compressors possible in a way to have, at any particular time, the highest number of compressors switched off.

- **Balancing:** the power is distributed on the highest number of compressors possible in a way to have, at any particular time, the supply levels of the compressors as balanced as possible.

### Fans

- **Fixed sequence:** when turning on the fan activation sequence is fan 1, fan 2 ... fan n; when turning off the sequence is reversed.
- **Rotation:** when turning on the fan that worked the least is selected, when turning off the fan that worked the most is selected in a way to balance the number of hours of operation.

## RUNNING TIME MANAGEMENT AND ALARM MAINTENANCE

This function allows the actual number of hours of operation of compressors and fans to be displayed at any time thus enabling alarm thresholds to be set for maintenance purposes. The hours of operation can be zeroed from the menu.

It is also possible to temporarily disable a compressor from the adjustment control; this function is very useful in case of maintenance of single compressors.

## MAXIMUM STOP TIME OF THE FANS

This function avoids the block of the condensation fans due to the formation of ice. The controller checks the period of inactivity of the fans and if this exceeds the number of hours

set as a parameter, it forces the simultaneous turning on of all the fans of the battery.

## FAN CONTROL VIA TRIAC OUTPUT

The new EWCM 4120 is equipped with an analog TRIAC output for the direct control of fans up to 2A without the aid of external accessories.

Both the duration of the pulse and the phase shift for the control of the TRIAC output can be configured to better suit the characteristics of the load.

In the control, the "fan regulator" output generates a phase cutoff signal that directly regulates the speed of the fan.

## DIAGNOSTICS AND ALARM HISTORY

The diagnostics of the new EWCM 32x74 are complete and signal any operating anomalies in the system with specific alarms, providing a clear indication on the display by turning on the dedicated icon and displaying its numeric code. Different alarm activation modes are available: automatic reset, manual reset or semiautomatic reset by event.

The triggering of the alarms associated to the safeties of the system can also be programmed by configuring the bypass time, the number of events and the activation mode. A Real Time Clock (RTC) with annual calendar records the date and time of triggering and reset of each alarm in an alarm history with circular saving of up to 100 events.



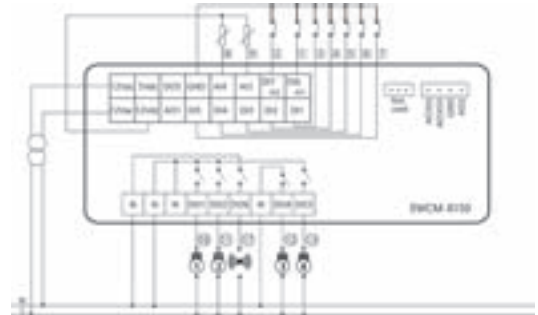
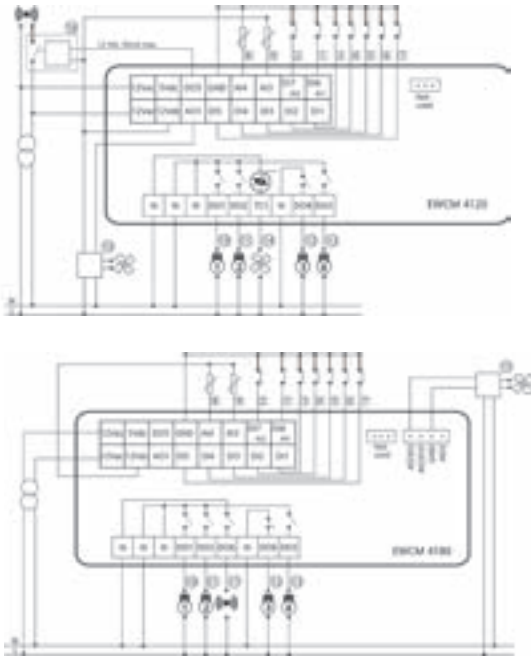



## ELECTRIC DIAGRAMS EWCM 4120 - 4150 - 4180





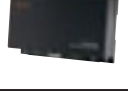





## FAMILY CODING 4120 - 4150 - 4180

	Code	Description						
4120	EM6A12001EL <sup>yy</sup>	EWCM 4120/C						
4150	EM6A22105EL <sup>yy</sup>	EWCM 4150/C						
4180	EM6A22101EL <sup>yy</sup>	EWCM 4180/C						
		<table border="1"> <tr> <td><sup>yy</sup></td> <td>10</td> <td>Standard code</td> </tr> <tr> <td></td> <td>11</td> <td>KIT code (with wiring)</td> </tr> </table>	<sup>yy</sup>	10	Standard code		11	KIT code (with wiring)
<sup>yy</sup>	10	Standard code						
	11	KIT code (with wiring)						

## ACCESSORIES

EWCM 13-18 DIN and EWCM 4120 - 4150 - 4180		<b>Probes NTC 103AT</b> , 1,5m <ul style="list-style-type: none"> <li>Plastic cap and 2 wire cable (SN691150)</li> <li>Metallic cap sized 6x40 and silicone cable (SN8S0A1500)</li> <li>TPE Steel cap sized 6x50, insulation class IP68 and PVC cable (SN8T6N1502)</li> </ul>
		<b>Pressure transducers</b> (Male/female recess) <ul style="list-style-type: none"> <li>EWPA007 4..20mA/-0.5..7bar, male (TD200107)</li> <li>EWPA007 4..20mA/-0.5..7bar, female (TD300008)</li> <li>EWPA030 4..20mA/0..30bar, male (TD200130)</li> <li>EWPA030 4..20mA/0..30bar, female (TD200030)</li> </ul>
		<b>Fan modules</b> <ul style="list-style-type: none"> <li>CFS: single-phase speed controllers for currents from 2A to 9A (various codes)</li> <li>CFS05 TANDEM: TRIAC 5A+5A/230V~ (various codes)</li> </ul>
		<b>PCInterface 2150</b> <ul style="list-style-type: none"> <li>RS-485 + TTL x ParamManager (PCI5A3000000)</li> </ul>
		<b>WebAdapter</b> <ul style="list-style-type: none"> <li>(WA0ET00X700)</li> </ul>
13-18 DIN		<b>ParamManager</b> from Vers. 5.2 <ul style="list-style-type: none"> <li>(SLP05XX000100)</li> </ul>
		<b>Televis</b> from Vers. 3.1 SP1
		<b>Eliwell Copy Card</b> USB to upload/download parameters <ul style="list-style-type: none"> <li>(CCA0BU102N000)</li> </ul>

EWCM 4120 - 4150 - 4180		<b>Transformers</b> <ul style="list-style-type: none"> <li>230V~/ / 12A 5VA VDE (TF411200)</li> </ul>
		<b>Ratiometric transducers</b> with female recess <ul style="list-style-type: none"> <li>EWPA010 R 0/5V 0/10bar (TD400010)</li> <li>EWPA030 R 0/5V 0/30bar (TD400030)</li> <li>EWPA050 R 0/5V 0/50bar (TD400050)</li> </ul>
		<b>Copy Card</b> to upload/download parameters <ul style="list-style-type: none"> <li>(CC0S00A00M000)</li> </ul>
		<b>Expansion module</b> with DIN rail mounting base <ul style="list-style-type: none"> <li>EXP211 230V 10A (MW320100)</li> </ul>
		<b>Wiring</b> <ul style="list-style-type: none"> <li>for user commands, L=1m (COHV000000100)</li> <li>to connect safe voltage inputs and outputs - SELV, L=1m (COLV000000100)</li> <li>ST500 - AO2/AO3, 3way, L=1m (COLV000042100)</li> </ul>
		<b>Fan modules</b> <ul style="list-style-type: none"> <li>CFS: single-phase speed controllers for currents from 2A to 9A (various codes)</li> <li>CFS05 TANDEM: TRIAC 5A+5A/230V~ (various codes)</li> </ul>
		<b>DRV300 three-phase fan controllers</b> <ul style="list-style-type: none"> <li>Power supply 12A/420V~-; box IP55 (LD312420T1S00)</li> <li>Power supply 20A/420V~-; box IP55 (LD320420T1S00)</li> <li>Power supply 12A/420V~-; box IP22 (LD312420T1G00)</li> <li>Power supply 20A/420V~-; box IP22 (LD320420T1G00)</li> </ul>
	<b>DeviceManager</b> CD <ul style="list-style-type: none"> <li>(DMP1000002000)</li> </ul>	

# EWCM Controllers for compressor unit

		8400	8600	8900	9100	9900	4120	4150	4180
Digital outputs	Relay	6 a 5A SPST 1 a 8A SPDT	6 a 5A SPST 2 a 8A SPDT	11 a 5A SPST 2 a 8A SPDT	11 a 5A SPST 2 a 8A SPDT	17 a 5A SPST 2 a 8A SPDT	4 a 2A SPST	5 a 2A SPST	5 a 2A SPST
	Open Collector						1	1	1
Analog outputs	0-10V, 4-20mA	1	1	1	2	3			
	TRIAC						1		
	PWM-Open Collector						1	2	2
	0-10V, 4-20mA, 0-20mA							1	1
Digital inputs	LV	2	2	2	4	6	7	7	7
	HV	6	10	10	10	14			
Analog inputs	4-20mA, 0-5V, 0-10V	1	1	1	2	3			
	NTC, PTC, DI	2	2	2	4	4			
	4-20mA, 0-5V, 0-10V, NTC, DI						2	2	2
Installation	-	DIN rail	DIN rail	DIN rail	DIN rail	DIN rail	32x74 panel	32x74 panel	32x74 panel
Power supply voltage	-	100-240 V~	100-240 V~	100-240 V~	100-240 V~	100-240 V~	12 V~	12 V~	12 V~
RTC	-	•	•	•	•	•	•	•	•
Connectivity	TTL						•	•	•
	RS-485	•	•	•	•	•			
	Ethernet	Ext	Ext	Ext	Int/Ext	Ext			
	Copy Card						•	•	•
	Eliwell USB Copy Card	•	•	•	•	•			
Keypad	128x64px LED backlit graphic LCD display	•	•	•	•	•			
	4 digit LED display						•	•	•
Menu languages	-	2 from p/n	2 from p/n	2 from p/n	2 from p/n	2 from p/n			
Televis/Modbus	-	•	•	•	•	•	•	•	•
ParamManager	-	• From version 5.2 and later	• From version 5.2 and later	• From version 5.2 and later	• From version 5.2 and later	• From version 5.2 and later	•	•	•
DeviceManager							•	•	•

## FUNCTIONAL CHARACTERISTICS

	8400	8600	8900	9100	9900	4120	4150	4180
Max no. of compressors	4	6	9	11	12	4	4	4
Compressor control	Step/Inverter	Step/Inverter	Step/Inverter	Step/Inverter	Step/Inverter	Step/Inverter	Step/Inverter	Step/Inverter
Intake adjustment	PID/ZN	PID/ZN	PID/ZN	PID/ZN	PID/ZN	P/ZN	P/ZN	P/ZN
Intake control sensor	Pressure temperature	Pressure temperature	Pressure temperature	Pressure temperature	Pressure temperature	Pressure temperature	Pressure temperature	Pressure temperature
Dynamic intake set point	•	•	•	•	•			
Master compressor	•	•	•	•	•			
Compressors of varying power	•	•	•	•	•			
No. of circuits	1	1	1	1	2	1	1	1
Max no. of fans				8	8	4		4
Fan control				Step/Inverter	Step/Inverter	Step/Inverter		Step/Inverter
Delivery adjustment				PID/ZN	PID/ZN	P/ZN		P/ZN
Delivery control sensor				Pressure temperature	Pressure temperature	Pressure temperature		Pressure temperature
Dynamic condensation set point				•	•			
Delivery max alarm prevention				•	•			
Fan stop max time				•	•	•		•
Heat recovery				•	•			
Liquid return control	•	•	•	•	•			
Timebands	•	•	•	•	•			
Operation history	•	•	•	•	•			
Alarm history	•	•	•	•	•	•	•	•